



SPECIFICATIONS

Trim for Wall Valve with Finial Lever

7.0046687T

See below for Valve Options

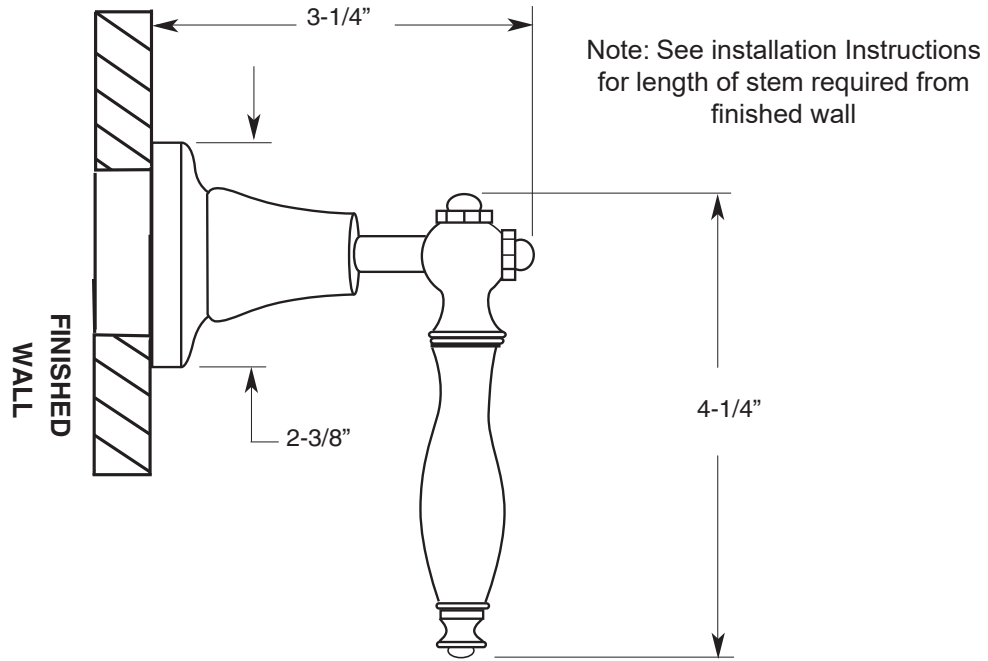

For use with the following valves:

- 78.30.020** - 1/2" Volume Control - 20 pt.....Replacement cartridge: 18.30.036
- 78.30.023** - 3/4" Volume Control - 20 pt.....Replacement cartridge: 18.30.011
- 78.30.255** - 3 port In-wall Diverter - 20 pt.....Replacement cartridge: 18.30.259
- 78.30.253** - 4 port In-wall Diverter - 20 pt.....Replacement cartridge: 18.30.257

Note: Measurements are subject to change or cancellation. No responsibility is assumed for use of superseded or voided pages.