

FEATURES:

- All brass construction.
- 3/4" valve bodies with 1/4-turn ceramic disc cartridge.
- 18.30.011 - HOT cartridge | 18.30.010 COLD cartridge
- Available in all finishes. Warranty varies according to finish selection.

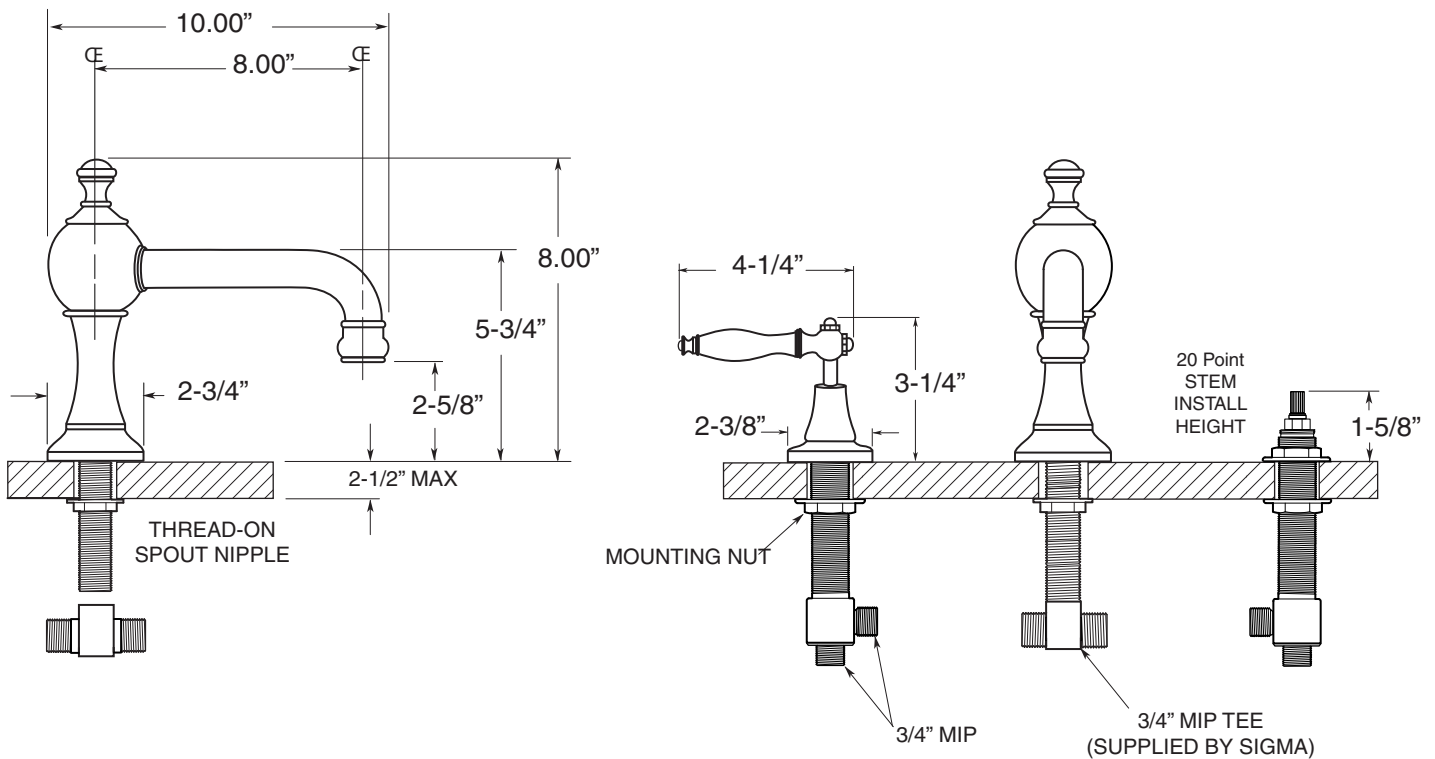

NOTE: Spout and valves install through 1-1/4" diameter holes.
Plumber to provide 3/4" supply lines to valves