

FEATURES:

- All brass construction
- 1/4 turn ceramic disc cartridge shut-offs.
- Replacement cartridge 18.30.430 - hot
- Floor flange has o’ring seal around riser to ensure tight fit.
- Available in all finishes. Warranty varies according to finish selection.

TechData
SPECIFICATIONS
Reserve

Collection
Risers and Shut-Off Kit
for use with Telephone
Handshower Set
(486) Finial Lever

7.78486246

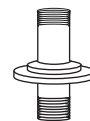
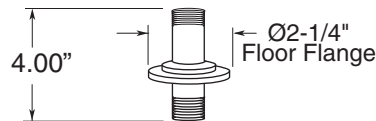
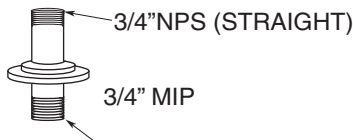
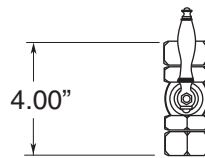
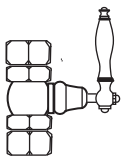
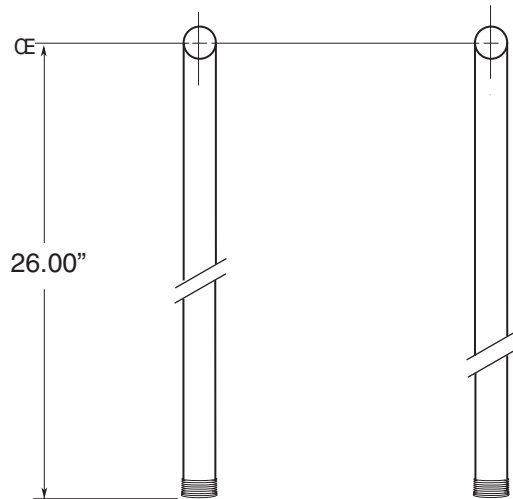
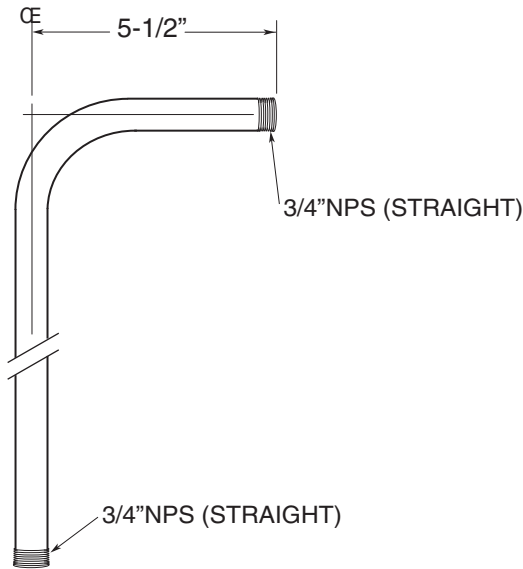

Note: Measurements are subject to change or cancellation. No responsibility is assumed for use of superseded or voided pages.