

E-Mini Thermostatic Trim W/ Rectangular Plate and Devon Handle

1.0S4551T

E-Mini Rectangular
Plate w/Integral Control

18.12.135

Volume/Diverter
Lever Assembly

18.12.817

Escutcheon

18.03.019

Left Lever

18.01.006

Right Lever

18.01.007

E-Mini Thermostatic Valve

18.30.292/18.30.291

Diverter/Shutoff Cartridge

18.30.903

Thermostatic
Cartridge

18.30.294

In-Wall Stem
Bushing

Stem Extensions
16PT and 20PT

[2] Sent with Valve
00.41.014

Locking Nut

Threaded Tube
with Locking Nut

Holding Nut

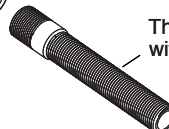
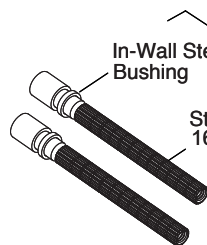
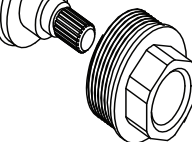
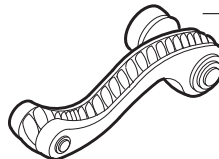
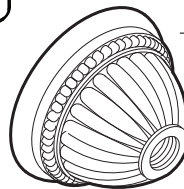
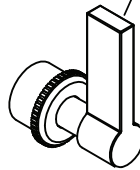
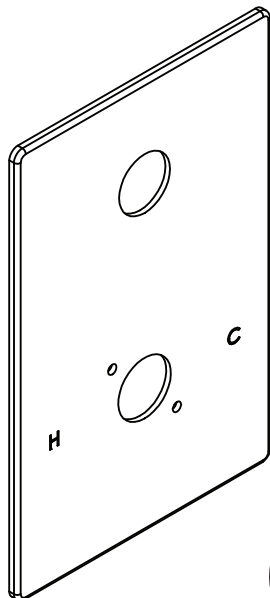
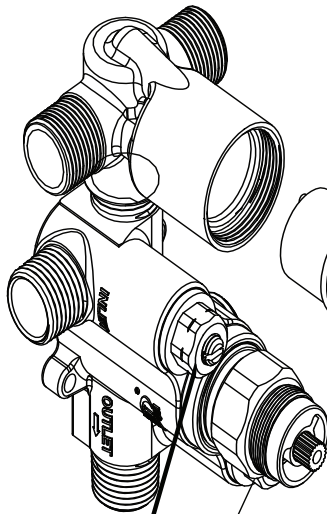

Screw Driver Check Valve

18.30.883A (Hot)
18.30.884A (Cold)